

Dokumentation

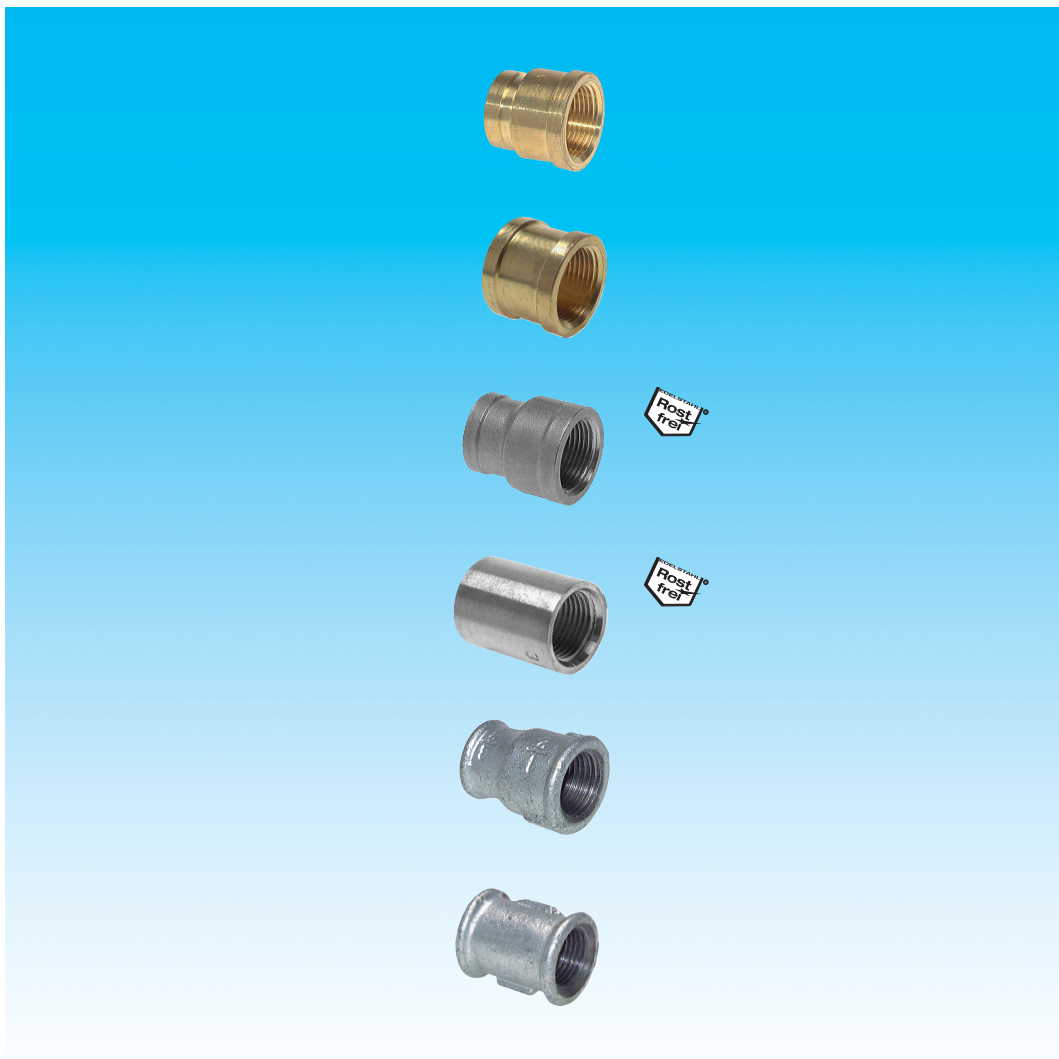



Muffen/Reduziermuffen - rund PN 16/25 - Typ MUR ... MS, MUR ... ES, MUR ... ST -



1. Inhalt

2. Artikelnummern und technische Daten	1
3. Abmessungen	2

2. Artikelnummern und technische Daten

Muffen/Reduziermuffen - rund				bis 25 bar		
Typ 16 bar Messing	Gewinde	Gewinde	Typ 16 bar 1.4408 	Typ 25 bar Temperguss verz.	Gewinde	Gewinde
---	G 1/8"	G 1/8"	MUR 18 ES	MU 18 ST	Rp 1/8"	Rp 1/8"
---	G 1/4"	G 1/8"	MUR 1418 ES	---	Rp 1/4"	Rp 1/8"
MUR 14 MS	G 1/4"	G 1/4"	MUR 14 ES	MU 14 ST	Rp 1/4"	Rp 1/4"
---	G 3/8"	G 1/8"	MUR 3818 ES	---	Rp 3/8"	Rp 1/8"
MUR 3814 MS	G 3/8"	G 1/4"	MUR 3814 ES	MU 3814 ST 	Rp 3/8"	Rp 1/4"
MUR 38 MS	G 3/8"	G 3/8"	MUR 38 ES	MU 38 ST	Rp 3/8"	Rp 3/8"
---	G 1/2"	G 1/8"	MUR 1218 ES	---	Rp 1/2"	Rp 1/8"
---	G 1/2"	G 1/4"	MUR 1214 ES	MU 1214 ST	Rp 1/2"	Rp 1/4"
MUR 1238 MS	G 1/2"	G 3/8"	MUR 1238 ES	MU 1238 ST	Rp 1/2"	Rp 3/8"
MUR 12 MS	G 1/2"	G 1/2"	MUR 12 ES	MU 12 ST	Rp 1/2"	Rp 1/2"
---	G 3/4"	G 1/4"	MUR 3414 ES	---	Rp 3/4"	Rp 1/4"
---	G 3/4"	G 3/8"	MUR 3438 ES	MU 3438 ST 	Rp 3/4"	Rp 3/8"
MUR 3412 MS	G 3/4"	G 1/2"	MUR 3412 ES	MU 3412 ST	Rp 3/4"	Rp 1/2"
MUR 34 MS	G 3/4"	G 3/4"	MUR 34 ES	MU 34 ST	Rp 3/4"	Rp 3/4"
---	G 1"	G 3/8"	MUR 1038 ES	---	Rp 1"	Rp 3/8"
MUR 1012 MS	G 1"	G 1/2"	MUR 1012 ES	MU 1012 ST	Rp 1"	Rp 1/2"
MUR 1034 MS	G 1"	G 3/4"	MUR 1034 ES	MU 1034 ST	Rp 1"	Rp 3/4"
MUR 10 MS	G 1"	G 1"	MUR 10 ES	MU 10 ST	Rp 1"	Rp 1"
---	G 1 1/4"	G 1/2"	MUR 11412 ES	MU 11412 ST	Rp 1 1/4"	Rp 1/2"
---	G 1 1/4"	G 3/4"	MUR 11434 ES	MU 11434 ST	Rp 1 1/4"	Rp 3/4"
MUR 11410 MS	G 1 1/4"	G 1"	MUR 11410 ES	MU 11410 ST	Rp 1 1/4"	Rp 1"
MUR 114 MS	G 1 1/4"	G 1 1/4"	MUR 114 ES	MU 114 ST	Rp 1 1/4"	Rp 1 1/4"
---	G 1 1/2"	G 3/4"	MUR 11234 ES	MU 11234 ST	Rp 1 1/2"	Rp 3/4"
---	G 1 1/2"	G 1"	MUR 11210 ES	MU 11210 ST	Rp 1 1/2"	Rp 1"
MUR 112114 MS	G 1 1/2"	G 1 1/4"	MUR 112114 ES	MU 112114 ST	Rp 1 1/2"	Rp 1 1/4"
MUR 112 MS	G 1 1/2"	G 1 1/2"	MUR 112 ES	MU 112 ST	Rp 1 1/2"	Rp 1 1/2"
---	G 2"	G 3/4"	MUR 2034 ES 	MU 2034 ST 	Rp 2"	Rp 3/4"
---	G 2"	G 1"	MUR 2010 ES	MU 2010 ST	Rp 2"	Rp 1"
---	G 2"	G 1 1/4"	MUR 20114 ES	MU 20114 ST	Rp 2"	Rp 1 1/4"
MUR 20112 MS	G 2"	G 1 1/2"	MUR 20112 ES	MU 20112 ST	Rp 2"	Rp 1 1/2"
MUR 20 MS	G 2"	G 2"	MUR 20 ES	MU 20 ST	Rp 2"	Rp 2"
---	G 2 1/2"	G 1 1/2"	---	MU 212112 ST	Rp 2 1/2"	Rp 1 1/2"
---	G 2 1/2"	G 2"	---	MU 21220 ST	Rp 2 1/2"	Rp 2"
---	G 2 1/2"	G 2 1/2"	MUR 212 ES	MU 212 ST	Rp 2 1/2"	Rp 2 1/2"
---	G 3"	G 1 1/2"	---	MU 30112 ST	Rp 3"	Rp 1 1/2"
---	G 3"	G 2"	---	MU 3020 ST	Rp 3"	Rp 2"
---	G 3"	G 2 1/2"	---	MU 30212 ST	Rp 3"	Rp 2 1/2"
---	G 3"	G 3"	MUR 30 ES	MU 30 ST	Rp 3"	Rp 3"
---	G 4"	G 2"	---	MU 4020 ST	Rp 4"	Rp 2"
---	G 4"	G 2 1/2"	---	MU 40212 ST	Rp 4"	Rp 2 1/2"
---	G 4"	G 3"	---	MU 4030 ST	Rp 4"	Rp 3"
---	G 4"	G 4"	MUR 40 ES	MU 40 ST	Rp 4"	Rp 4"

Besonders preiswert!



Typ 240/M2 red



Typ 270/M2

3. Artikelnummern und technische Daten

MUR ... ES

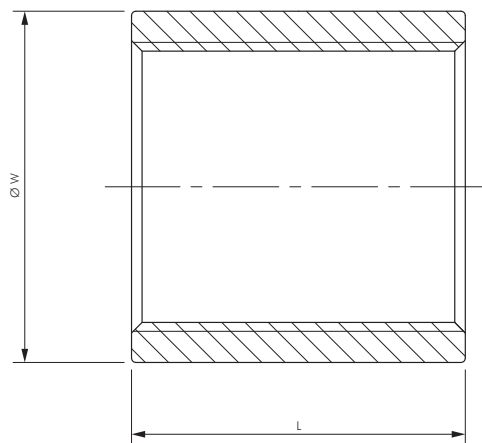

Typ 16 bar 1.4408			
	Gewinde	L	Ø W
MUR 18 ES	Rp 1/8"	20,0	13,5
MUR 14 ES	Rp 1/4"	25,0	18,0
MUR 38 ES	Rp 3/8"	25,0	21,5
MUR 12 ES	Rp 1/2"	33,0	26,0
MUR 34 ES	Rp 3/4"	35,0	31,5
MUR 10 ES	Rp 1"	42,5	39,0
MUR 114 ES	Rp 1 1/4"	46,5	47,5
MUR 112 ES	Rp 1 1/2"	46,0	54,0
MUR 20 ES	Rp 2"	54,5	66,5
MUR 212 ES	Rp 2 1/2"	65,0	83,0

MUR ... MS

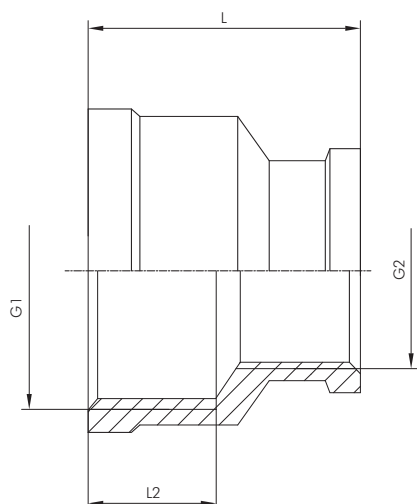

Typ 16 bar Messing			
	G1	G2	L
MUR 3814 MS	G 3/8"	G 1/4"	23,0
MUR 1012 MS	G 1"	G 1/2"	32,5